

Kirby Morgan®

KMB 18/28 BandMask®

A2.1

Annual Inspection/Overhaul/Maintenance Checklist

THIS INSPECTION AND MAINTENANCE SHOULD BE PERFORMED **AT LEAST ANNUALLY** AND AS DICTATED BY CONDITION REVEALED DURING DAILY/MONTHLY INSPECTION. MONTHLY INSPECTIONS DETERMINE NECESSITY FOR OVERHAUL WITH MORE ACCURACY THAN SIMPLY PLACING A NUMBER OF HOURS OF USE.

This checklist is intended to aid persons performing routine overhauls of the KMDSI KMB 18/28 Band Masks. The checklist should be used in conjunction with the latest version of the KMDSI Modular Operations and Maintenance Manual for the KMB 18 and 28 BandMasks. This checklist is primarily intended to document the maintenance as it is completed and to help guide the technician during overhauls. Specific detailed procedures for each section of this checklist can be found in the Modular Operations and maintenance manuals. This checklist, when completed should be retained in the equipment maintenance files. This checklist is generic in nature and should be used for all models of the KMDSI Band Masks.

⚠ WARNING

These are recommended minimum checks when using Kirby Morgan Helmets or Masks. Additional checks may be required as dictated by the conditions and tasks being performed. Failure to perform in-water checks may result in serious injury or death.

⚠ WARNING

Counterfeits, although similar in appearances (including packaging), are not the same strength or quality. Please DO NOT be fooled into thinking they are the “real thing”. Spare parts obtained from unauthorized sources may be made of inferior materials, not to specifications and poor quality that will interfere with the performance characteristics of the life support equipment and may jeopardize the diver’s safety. This can lead to improper function or failure of your Kirby Morgan® equipment, possibly causing serious injury or death!



NOTE

When performing the A2.1 as a scheduled overhaul, all O-rings must be replaced. When using the A2.1 as an “inspection” only, in-between annual overhauls, O-rings and exhaust valves may be reused if inspection reveals the soft goods are serviceable.



NOTE

KMDSI strongly recommends that all repairs be performed by trained personnel.



NOTE

Masks being used in extreme environments will require more frequent inspection.

This checklist should be used in conjunction with the most current KMDSI Modular Operations and Maintenance Manual. Please check the KMDSI web page at www.kirbymorgan.com.

Date: 03.02.2026Mask Model and Serial Number 22446BRegulator Serial Number/Model 455 No Serial NumberTechnician (*print name*): Daniel kristensen

1. Hood Assembly



CHECK THE FOLLOWING:

Procedures	Initials
<p>1. . Remove Head Harness (Spider) and inspect for signs of tearing, deterioration, and/or damage. Ensure all five legs of the Spider are present. Replace if necessary.</p> <p>GUIDANCE: BandMask Hood, Face Seal, Band Keepers and Head Harness (HBNK)</p>	DK
<p>2. Remove the Earphones from their pockets in the Hood. Remove the Hood from the Mask. Perform a visual inspection of all components.</p> <p>GUIDANCE: BandMask Hood, Face Seal, Band Keepers and Head Harness (HBNK)</p>	DK
<p>3. Visually inspect the Hood for signs of damage, and/or deterioration. Replace if necessary.</p> <p>GUIDANCE: BandMask Hood, Face Seal, Band Keepers and Head Harness (HBNK)</p>	DK
<p>4. Remove the Top and Bottom Bands from the Hood. Visually inspect all metal parts of the Band Assembly and Band Keeper components, including the Band Screws, for damage. Replace if necessary.</p> <p>GUIDANCE: BandMask Hood, Face Seal, Band Keepers and Head Harness (HBNK)</p>	DK

2. Mask Assembly

CHECK THE FOLLOWING:

Procedures	Initials
<p>1. Visually inspect the Mask exterior and interior for loose and/or missing fasteners and obvious signs of damage; including cracks, gouges, and/or depressions</p> <p>On the KMB 18 any gouge into the gel coat that penetrates through to the fiberglass MUST be repaired immediately. Any gouge deeper than 1/8" (1.5mm) should be checked by a certified technician from KMDSI or Dive Lab, Inc. Only KMDSI technicians certified in Helmet Shell/BandMask® repairs by KMDSI or Dive Lab, Inc. are authorized to perform helmet shell repairs. Any cracks or damage in the plastic frame of the KMB 28 will require replacement of the frame. Further info contact Dive Lab divelab@divelab.com (850) 235-2715.</p> <p> NOTE</p>	DK
<p>2. Remove the Covers from the Earphones. Remove Microphone from the Oral Nasal Mask. Inspect and repair/replace as necessary. Perform a complete communications check.</p> <p>GUIDANCE: Communications on SuperLite® 17B and 17C Helmets, KMB 18 and 28 BandMasks® (17COM)</p>	DK
⚠ CAUTION	
<p>The Nose Block device MUST be removed when removing or installing the Oral Nasal Mask. Stretching the Oral Nasal Mask over the Nose Block Device will cause the Oral Nasal Mask to tear.</p>	
<p>3. Remove the Nose Clearing Device. Clean and inspect the Nose Clearing Pad and Shaft. Replace O-rings.</p> <p>GUIDANCE: Face Port, Port Retainer and Nose Block (FCPRT)</p>	DK
<p>4. Remove Oral Nasal Mask and Oral Nasal Valve as an assembly. Remove Valve and Valve Body as an assembly. Clean and inspect Mask for damage. Replace Valve and reinstall into Valve Body. Reinstall Valve Body into Mask.</p> <p>GUIDANCE: Oral Nasal Mask (ON)</p>	DK
<p>5. Remove the Comfort Insert [KMB 18 only]. Clean and inspect the Comfort Insert and fastening hardware for damage and/or deterioration. Mark N/A for KMB 28.</p>	NA

Procedures	Initials
<p>6. Remove the bent tube and replace the Teflon® O-ring on the side block end of the bent tube, as well as the O-ring at the demand regulator inlet side of the bent tube.</p> <p> NOTE Replace the bent tube if it is excessively scratched, dented, or compressed deeper than 1/8" (3.18 mm). Check for erosion of the metal and severe corrosion. Replace if any erosion is present or integrity is in question.</p>	DK
<p>7. Remove the Demand Regulator with whisker wings and exhaust main body as a single unit from the Mask and set it aside.</p> <p>GUIDANCE: 455 Balanced Regulator (455BAL) or SuperFlow® 350 Regulator (SF350)</p>	DK
<p>8. Remove the exhaust main body, along with both the right and left whiskers from the regulator body. Completely disassemble the exhaust system, clean, and inspect it. Replace rubber components of the exhaust system if they show any signs of deterioration, wear, or damage.</p> <p>GUIDANCE: BandMask Tri-Valve Exhaust (BTRI)</p>	DK
<p>9. Replace the exhaust valves at least annually or whenever they show signs of deterioration, wear, or damage.</p> <p>GUIDANCE: BandMask Tri-Valve Exhaust (BTRI)</p>	DK
<p>10. Remove the Face Port Retainer, Face Port and O-ring.</p> <p>GUIDANCE: Face Port, Port Retainer and Nose Block (FCPRT)</p> <p> NOTE The face port should be replaced whenever cracks are present, whenever nicks and scratches deeper than 1/6" (1.5 mm) are found, or whenever the condition is questionable.</p>	DK
<p>11. Perform View Port Insert Pull Test and complete the port insert test sheet (A2.1 MUST include the completed test sheet). Replace the View Port O-ring.</p> <p>If the inserts fail, the KMB 18 shell will need to be sent to an authorized KMDSI repair facility. If the KMB 28 inserts fail, the shell will have to be replaced.</p> <p>GUIDANCE: Thread Insert Testing Procedure found on the Kirby Morgan website under Support > Checklists > Misc. Appendices</p>	DK

Procedures	Initials
12. Install top band keeper mount, and lower band keeper mount (if removed). GUIDANCE: BandMask Hood, Face Seal, Band Keepers and Head Harness (HBNK)	DK
Water Dump Body removed? <input checked="" type="checkbox"/> Yes <input type="checkbox"/> No  NOTE You do not need to physically remove the Water Dump Body from the KMB 18 frame each year unless there is excessive corrosion. KMDSI recommends that, at a minimum, the Water Dump Body be removed from the mask, cleaned, and reinstalled at least every three (3) years, in accordance with the modular O & M Manual. 13. Remove the Main Exhaust Valve Cover and replace the Main Exhaust/Dewatering Valve. Inspect seating surface for damage and/or contamination. GUIDANCE: BandMask Tri-Valve Exhaust (BTRI)	DK

3. Side Block

 **NOTE** The Side Block does not need to be physically removed from the Helmet Shell every year in order to overhaul the Steady Flow, Emergency and One Way Valve providing excessive internal corrosion is not present in the side block passages or valve components. However, all valves must be overhauled and soft goods changed in accordance with the Operations and Maintenance manual. **KMDSI recommends at least every THREE (3) years the Side Block Assembly be physically removed from the Helmet, overhauled and reinstalled, per Modular O & M Manual.**

CHECK THE FOLLOWING:

Procedures	Initials
Side Block removed? <input checked="" type="checkbox"/> Yes <input type="checkbox"/> No	
1. Remove, disassemble and overhaul the One-Way Valve. GUIDANCE: One Way Valve (OWV)	DK
2. Remove, discard, and replace Umbilical Adapter with a new one.	DK,SS

Procedures	Initials
<p>3. Remove, disassemble, and overhaul the EGS and Steady Flow Valve components.</p> <p>GUIDANCE: Brass/Chromed Brass Side Block (SB)</p> <p> It is not required to remove the EGS Valve on the Side Block for the annual overhaul. However, if the Side Block is to be removed or the EGS Valve exhibits excessive corrosion/verdigris, the EGS Valve will require removal, cleaning, and re-sealing with Teflon® tape.</p> <p>NOTE</p>	<p>DK</p>

4. Demand Regulator



KMDSI recommends replacing the soft goods, including diaphragm and exhaust valves, on all Demand Regulator models at least once a year or as indicated by their condition during daily or monthly inspections. Monthly inspections will provide a more accurate assessment of whether an overhaul is needed.

CHECK THE FOLLOWING:

Procedures	Initials
<p>1. Disassemble the Demand Regulator. Visually inspect the interior of the Regulator Body for corrosion and/or contamination. Clean as necessary.</p> <p>GUIDANCE: 455 Balanced Regulator (455BAL) or SuperFlow® 350 Regulator (SF350)</p> <p>As a general guideline dents in the regulator cover should not exceed 1/8"/3.2 mm.</p> <p>Additional guidance on when a SuperFlow®/SuperFlow® 350 regulator cover may need to be replaced:</p> <ul style="list-style-type: none"> • Sharp dents may require cover replacement even if they do not exceed 1/8"/3.2 mm • Dents that deform the regulator cover slots. These slots are critical for proper regulator function. • Dents next to the purge button which prevent smooth operation of the button • Old regulator covers that appear rippled and thin from long term use. • If there's any doubt about the integrity of the cover it should be replaced. 	<p>DK</p>

Procedures	Initials
<p>2. After the Regulator has been disassembled, clean and inspect all parts. Replace ALL O-rings and the inlet valve seat. On Superflow & Superflow 350 regulators, the Adjustment Lock Nut on the inlet valve shaft must never be reused. If the Adjustment Lock Nut is reused, the Regulator may not maintain proper</p> <p>GUIDANCE: BandMask Tri-Valve Exhaust (BTRI)</p>	DK
<p>3. Reassemble the Demand Regulator.</p> <p>GUIDANCE: 455 Balanced Regulator (455BAL) or SuperFlow® 350 Regulator (SF350)</p>	DK
<p>4. Ensure the Adjustment Shaft P/N 550-057 rotates smoothly and there is no binding.</p>	DK
<p>5. Install the Exhaust Main Body onto the Exhaust Flange of the Regulator and attach the whiskers to each side of the View Port Retainer.</p> <p>GUIDANCE: BandMask Tri-Valve Exhaust (BTRI)</p>	DK
<p>6. Mount the Regulator to the Mask.</p> <p>GUIDANCE: 455 Balanced Regulator (455BAL) or SuperFlow® 350 Regulator (SF350)</p>	DK
<p>7. Install the bent tube. Ensure the Teflon® washer and O-ring have been replaced.</p> <p>GUIDANCE: Bent Tube (BNT)</p>	DK
<p>8. Reinstall Oral Nasal Mask, Valve Assembly, and Nose Block Device.</p> <p>GUIDANCE: Oral Nasal Mask (ON) and Face Port, Port Retainer and Nose Block (FCPRT)</p>	DK
<p>9. Check the Regulator for proper operation and fine tune the adjustment if necessary.</p> <p>GUIDANCE: 455 Balanced Regulator (455BAL) or SuperFlow® 350 Regulator (SF350)</p>	DK



5. Emergency Gas Supply (EGS)



The Emergency Gas System consists of a good quality First Stage Regulator equipped with a submersible pressure gauge, an Over Pressure Bleed/Relief Valve, and an Emergency Gas Supply Hose that connects to the Emergency Valve on the Mask Side Block.

CHECK THE FOLLOWING:

Procedures	Initials
<p>1. Check the hydrostatic date and last visual inspection record (“VIP”) of the cylinder. Ensure date(s) are within the specified range. The VIP is done at least annually and the hydrostatic test is done at least every five years.</p>	-
<p>2. Check the maintenance record of the EGS components to ensure the First Stage Regulator’s maintenance has been performed in accordance with the manufacturer’s recommendations.</p>	-
<p>3. Check all hoses for signs of blisters, cover slippage, cuts, abrasions, corrosion, and internal contamination. Pressure test the hose assembly to 250 psig (17 Bar) if there is any doubt about the hose’s integrity. Replace any hoses or fittings that show signs of leakage or damage. KMDSI recommends testing hoses at the maximum working pressure of the hose being used at least once a year. If a Quick Connect EGS hose is being used, inspect quick connect and fittings for signs of wear/damage. Replace O-rings as necessary.</p>	DK
<p>4. Check the submersible pressure gauge, ensure it has been compared to a gauge of known accuracy, and document the results. Inspect the HP submersible hose for signs of corrosion and damage. Replace the hose if any damage is found. KMDSI recommends that all EGS HP hoses be leak- and pressure-checked at least once a year or to the maximum working pressure it will be used at.</p>	DK
<p>5. Overhaul and test the Over Pressure Relief Valve.</p> <p>GUIDANCE: Overpressure Relief Valve (OPRV) or KMDSI Bleed/Relief Valve Cleaning, Inspection, and Overhaul Procedure</p>	DK

Procedures	Initials
<p>6. Log the lifting pressure _____ psig.</p> <p> A regulated pressure of at least 200 psig (14 Bar) is necessary for adjusting the overpressure relief valve.</p> <p>NOTE</p> <p> The Overpressure Relief Valve should be adjusted to start relieving between 180–200 psig (12–14 bar) when tested.</p> <p>NOTE</p>	
<p>7. Check the intermediate pressure setting of the First Stage to ensure it is within the manufacturer’s specified pressure range. For KMDSI Helmets and Masks, the recommended intermediate pressure for the emergency supply is normally between 135 psig to 165 psig (9–11 bar). Log the intermediate pressure.</p>	DK
<p>8. Perform a leak check of all EGS components and fittings using soapy water in a pressurized condition. Repair/replace items as necessary.</p>	DK
<p>9. Inspect the Harness Assembly for signs of wear and/or damage. Repair/replace as necessary. Document any inspection/maintenance on the Maintenance Log (Appendix 3).</p>	DK

Recorded in service records for BandMask® and EGS System (maintenance log books)? Yes No

Recorded service in BandMask® maintenance log book? Yes No



I Daniel kristensen hereby certify that I have performed the work required in the A2.1 and that **I AM** a certified KMDSI / Dive Lab technician.

Print Name: Daniel kristensen

Signature:  Date: 03.02.2026

ID #: T-21683 Date of Certification: _____



I _____ hereby declare that I have performed the work required in the A2.1 and **I AM NOT** a certified KMDSI/Dive Lab technician.

Technician/Owner Print Name: _____

Signature: _____ Date: _____

Comments: _____

KMDSI strongly recommends that a certified KMDSI Repair Technician make all repairs and that only genuine KMDSI repair and replacement parts be used. Owners of KMDSI products that elect to do their own repairs and inspections should only do so if they possess the knowledge and experience. All inspections, maintenance, and repairs should be completed using the appropriate KMDSI user guide and Operations and Maintenance Manual(s). Persons performing repairs should retain all replacement component receipts for additional proof of maintenance history. Should any questions on procedures, components, or repairs arise, please contact Kirby Morgan Dive Systems, Inc., by telephone at (805) 928-7772 or via e-mail at kmdsi@kirbymorgan.com, or contact Dive Lab, Inc., by telephone at (850) 235-2715 or via e-mail at divelab@divelab.com.



NOTE The Maintenance Log, Appendix 3, found in the Misc. Appendices checklists on the Kirby Morgan website, may be used as a template to create blank pages to record all the maintenance performed.

Port Insert Test Sheet

Test Results:

P=Pass F=Fail

- 1 _____
- 2 _____
- 3 _____
- 4 _____
- 5 _____
- 6 _____
- 7 _____
- 8 _____
- 9 _____
- 10 _____
- 11 _____
- 12 _____
- 13 _____
- 14 _____
- 15 _____

Date _____ Company _____

Helmet/KMB Model _____ SN# _____

Technician _____

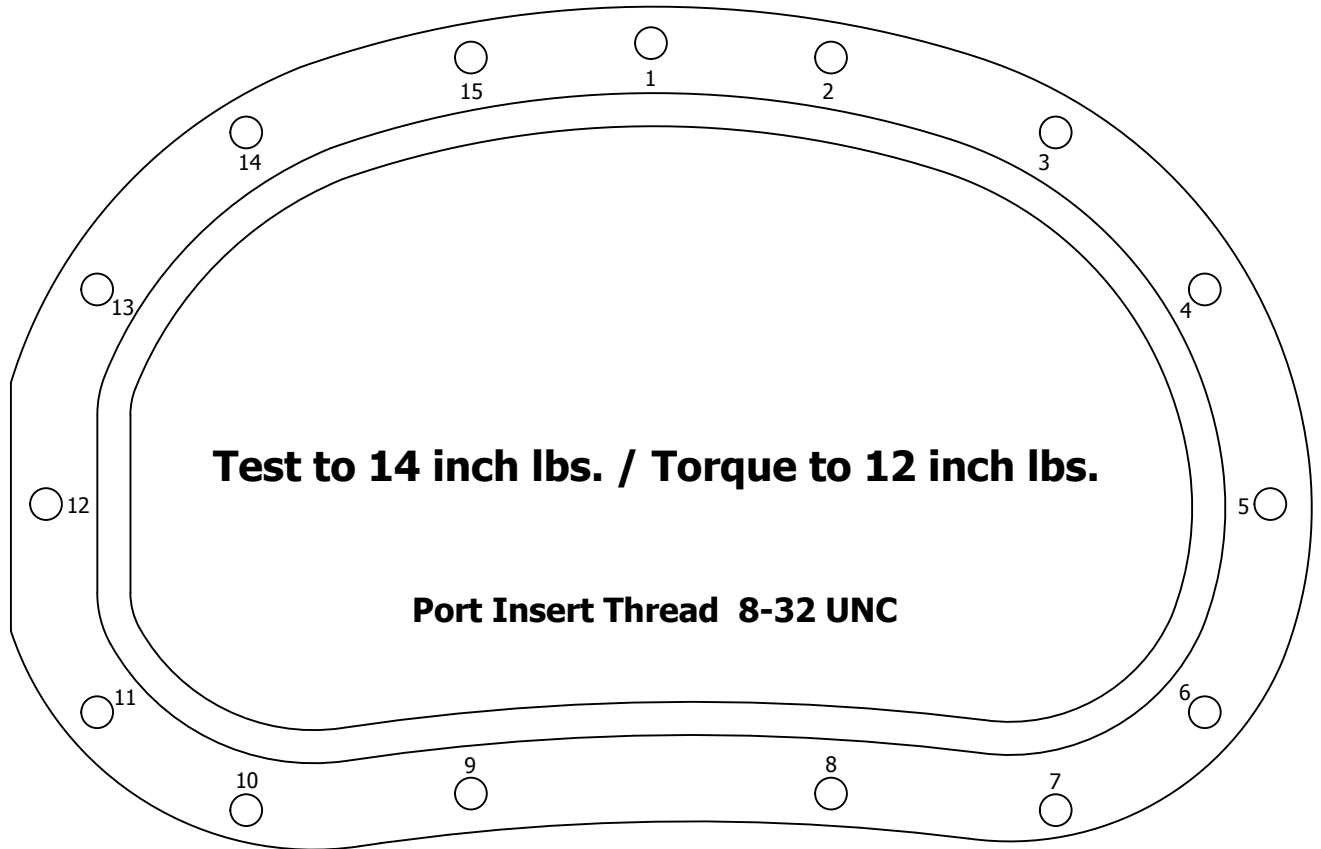

Notes/Comments: _____
